

TENTATIVE TOSHIBA BIPOLAR LINEAR INTEGRATED CIRCUIT SILICON MONOLITHIC

TA1270BF

PAL / NTSC VIDEO AND CHROMA SYNC PROCESSING SYSTEM FOR PIP / POP / PAP

TA1270BF is a PAL/NTSC color TV signal processor IC suitable for PIP/POP/PAP. The IC integrates video and chroma sync processor circuits. It comes in a 48pin flat package.

The video block uses a chroma trap, the chroma block a PAL/NTSC automatic identifier circuit, and the sync processor block a 50/60 Hz automatic identifier circuit. The PAL demodulator circuit contains a baseband signal processor, making the circuit adjustment free.

The TA1270BF incorporates an I²C bus, enabling control to be set via the bus line.

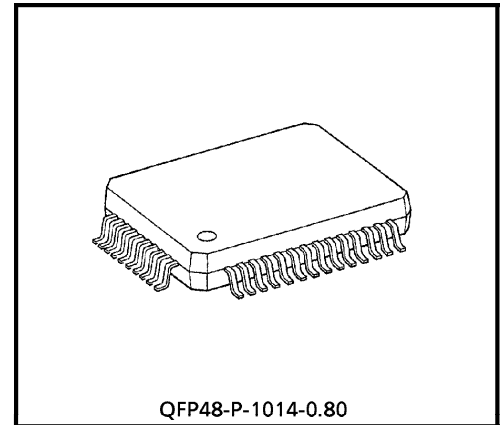

Weight : 0.83 g (Typ.)

FEATURES

Video block

- Chroma trap
- Y delay line
- Sub contrast adjustment (± 3 dB)

CHROMA block

- UV/CbCr demodulation for NTSC ; UV demodulation for PAL
- Tint control
- PAL demodulation baseband signal processing
- PAL/NTSC automatic identification
- Sub color adjustment (± 3 dB)

980910EBA1

- TOSHIBA is continually working to improve the quality and the reliability of its products. Nevertheless, semiconductor devices in general can malfunction or fail due to their inherent electrical sensitivity and vulnerability to physical stress. It is the responsibility of the buyer, when utilizing TOSHIBA products, to observe standards of safety, and to avoid situations in which a malfunction or failure of a TOSHIBA product could cause loss of human life, bodily injury or damage to property. In developing your designs, please ensure that TOSHIBA products are used within specified operating ranges as set forth in the most recent products specifications. Also, please keep in mind the precautions and conditions set forth in the TOSHIBA Semiconductor Reliability Handbook.
- The products described in this document are subject to the foreign exchange and foreign trade laws.
- The information contained herein is presented only as a guide for the applications of our products. No responsibility is assumed by TOSHIBA CORPORATION for any infringements of intellectual property or other rights of the third parties which may result from its use. No license is granted by implication or otherwise under any intellectual property or other rights of TOSHIBA CORPORATION or others.
- The information contained herein is subject to change without notice.

Sync processor block

- High-performance sync separator circuit
- Adjustment-free horizontal and vertical oscillator circuit using count down method
- 50 / 60 Hz automatic identifier circuit

Switch block

- High-speed switcher circuit
- YUV or RGB input
- Built-in RGB matrix circuit
- YUV or RGB output

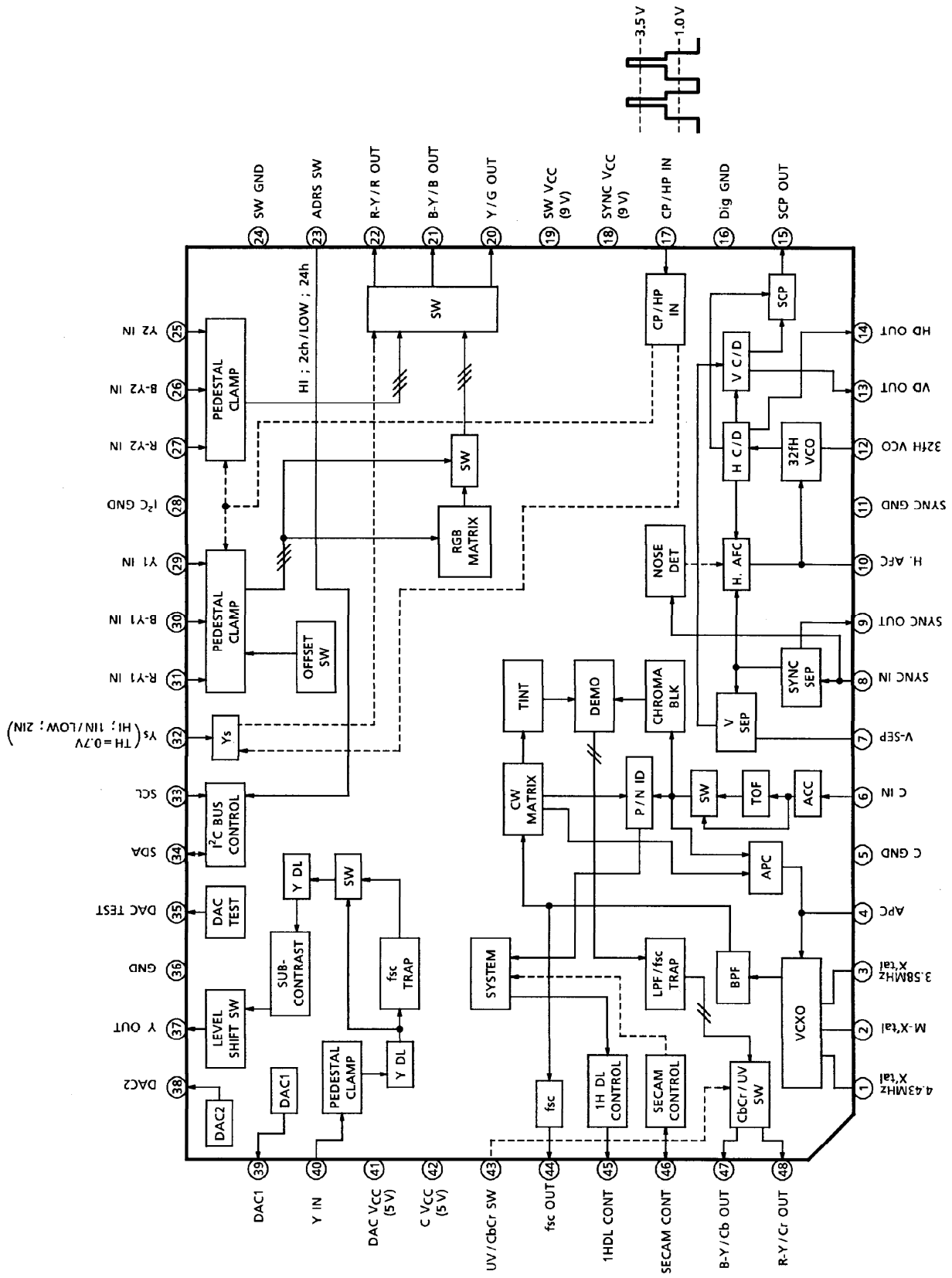

BLOCK DIAGRAM



PIN FUNCTION

PIN No.	PIN NAME	FUNCTION	INTERFACE	INPUT / OUTPUT SIGNAL
1 2 3	X'tal-1 X'tal-2 X'tal-3	Connect crystal. Serial capacitance can vary oscillator frequency f_0 ; parallel capacitance can vary oscillator adjustment range.		DC 4.0 V 90 mV _{p-p}
4	APC filter	Connect APC filter for CHROMA demodulation. The voltage of this pin determines the VCXO oscillator frequency.		DC
5	C GND	CHROMA processor GND pin	—	—
6	CHROMA input	CHROMA input pin. Input CHROMA signal after Y/C separation.		Burst signal : 300 mV _{p-p} 2.5 V GND
7	V-SEP	Connect vertical sync separation filter.		DC 6.4 V

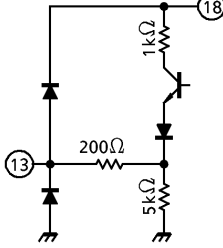
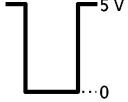
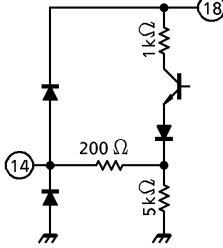
PIN No.	PIN NAME	FUNCTION	INTERFACE	INPUT / OUTPUT SIGNAL
8	Sync input	Sync separator circuit input pin. Input via the clamp capacitor.		
9	Sync output	Outputs sync signal separated using the sync separator circuit. Open collector output. Connect a pull-up resistor.		
10	AFC filter	Connect a horizontal AFC filter. The voltage of this pin determines the horizontal output frequency.		DC
11	SYNC GND	Sync processor GND pin	—	—
12	32 fH VCO	Connect a ceramic oscillator for horizontal oscillation. Use a CSB503F30 oscillator manufactured by Murata Mfg Co., Ltd.		

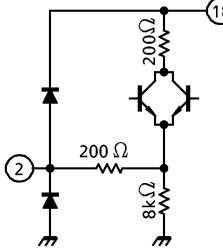
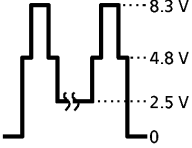
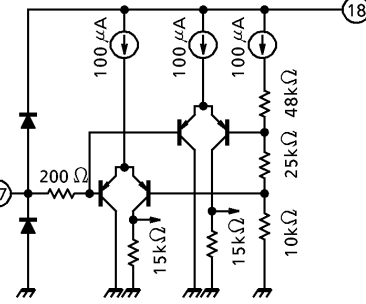
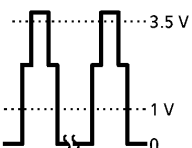
PIN No.	PIN NAME	FUNCTION	INTERFACE	INPUT / OUTPUT SIGNAL
13	VP output	Vertical pulse output pin		
14	HD output	Outputs HD pulse processed by the AFC. HD output phase or pulse width can be changed by bus setting.		
15	SCP output	Outputs sand castle pulse (SCP). The output signals are clamp pulse, horizontal blanking pulse, and vertical blanking pulse. The minimum load resistance is 3 kΩ.		
16	Dig GND	Logic block GND pin	—	—
17	CP / HP input	Input pin for CP / HP pulse used to operate the SW circuit. CP is used as clamp pulse ; HP as blanking pulse.		
18	SYNC VCC	VCC pins for sync processor block and SW block.	—	—
19	SW VCC	Connect 9 V (Typ.).	—	—

PIN No.	PIN NAME	FUNCTION	INTERFACE	INPUT / OUTPUT SIGNAL
20 21 22	Y/G output B-Y/B output R-Y/R output	Output Y/B-Y/R-Y or R/G/B. YUV/RGB output is switched by bus setting.		
23	ADRS SW	Pin used to switch slave addresses. GND — 24H, VCC — 2CH		2CH — 0.7 V 24H — GND
24	SW GND	Switch block GND pin	—	—
25 26 27	Y2 input B-Y2 input R-Y2 input (YUV2)	Y2/B-Y2/R-Y2 (YUV2 input) or R2/G2/B2 input pin. Input via capacitor used for clamp operation.		
28	I ² C GND	I ² C block GND pin	—	—
29 30 31	Y1 input B-Y1 input R-Y1 input (YUV1)	Y1/B-Y1/R-Y1 (YUV1 input) or R1/G1/B1 input pin. Input via capacitor used for clamp operation.	Same as those for pins 25, 26 and 27	
32	Ys	High-speed switch for switching input pins 25, 26, and 27 (YUV2) and input pins 29, 30, and 31 (YUV1). The threshold is 0.7 V.		YUV1 — 0.7 V YUV2 — GND

PIN No.	PIN NAME	FUNCTION	INTERFACE	INPUT / OUTPUT SIGNAL
33	SCL	I ² C Bus SCL pin		—
34	SDA	I ² C Bus SDA pin		—
35	DAC TEST	DAC monitor pin for IC shipping inspection.		—
36	GND	GND pin	—	—
37	Y output	Outputs Y signal which passed fsc trap (trap is set on or off by Bus) and Y delay line circuit.		
38 39	DAC2 DAC1	1 bit DAC output pins		—

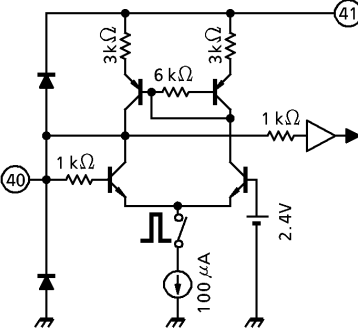
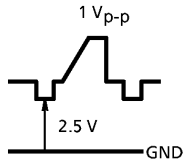
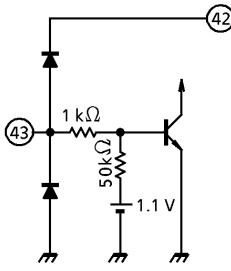
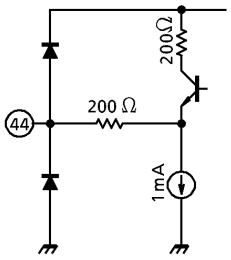
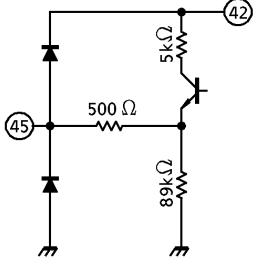
PIN No.	PIN NAME	FUNCTION	INTERFACE	INPUT / OUTPUT SIGNAL
40	Y input	Composite video signal or Y signal input pin. Input via the clamp capacitor.		
41 42	DAC V _{CC} C V _{CC}	V _{CC} pins for DAC block and CHROMA processing block. Connect 5 V (Typ.).	—	—
43	UV / CbCr SW	UV / CbCr demodulation switch. OPEN — UV GND — CbCr CbCr demodulation is effective for NTSC only.		<p>UV — 0.7 V CbCr — 0</p>
44	fsc output	Outputs crystal oscillator fsc. The pin voltage goes high only when 3.58NTSC is received.		<p>AC ; 0.6 V_{p-p} DC ; 3.58NTSC — 3.2 V OTHERS — 1.4 V</p>
45	1HDL CONT	Outputs PAL / SECAM / NTSC identification result. Adjust to DC and connect output to 1H DL IC.		<p>4.3 V ; PAL 2.5 V ; SECAM 0 V ; NTSC</p>

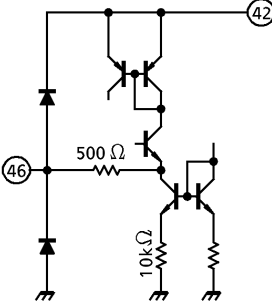
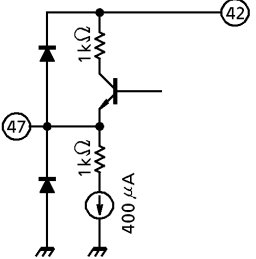
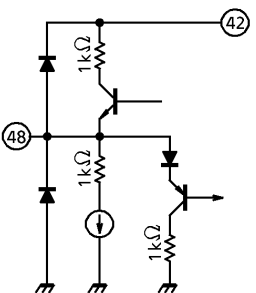
PIN No.	PIN NAME	FUNCTION	INTERFACE	INPUT / OUTPUT SIGNAL
46	SECAM CONT	I/O pin used to control SECAM demodulator IC. If 250 μ A or more flows from this pin, SECAM is determined.		At PAL / NTSC : 4.0 V At SECAM (Black and white) : 0.75 V
47	B-Y / Cb output	Outputs B-Y (U) signal or Cb signal. Incorporates LPF to reject carrier.		DC ; 2.5 V Rainbow color bar ; 360 mV _{p-p}
48	R-Y / Cr output	Outputs R-Y (V) signal or Cr signal. Incorporates LPF to reject carrier. Pulling up the pin with 10 k Ω monitors CHROMA signal after ACC and TOF circuits (before demo input).		DC ; 2.5 V Rainbow color bar ; 360 mV _{p-p}

BUS CONTROL MAP

Write data

Slave address : 24H (00100100) pin 23-GND or 2CH (00101100) pin 23-V_{CC}

SUB ADDRESS	D7 MSB	D6	D5	D4	D3	D2	D1	D0 LSB	POWER-ON INITIAL VALUE	
									MSB	LSB
00	TINT							DAC1	1000	0000
01	TOF-f0			TOF-Q			Y-DL	P/N-ID	1000	0000
02	SUB CONTRAST					C-TRAP	HD-PHS	DAC2	1000	0000
03	SUB COLOR					COLOR SYSTEM			1000	0000
04	Y BLACK LEVEL ADJ.				SW-OFT	V-FREQ / AFC-G			1000	0000
05	R-Y BLACK LEVEL ADJ.						GP-PHS	Y-OFST	1000	0000
06	B-Y BLACK LEVEL ADJ.						OUTPUT MODE		1000	0000

Write data

Slave address : 25H (00100101) pin 23-GND or 2DH (00101101) pin 23-V_{CC}

	D7	D6	D5	D4	D3	D2	D1	D0
0	PORET	COLOR SYSTEM		X'tal		V-FREQ	V-STD	H-LOCK
1	PORET	COLOR SYSTEM		X'tal		N-DET	Y/V-IN	Y-IN

BUS CONTROL FUNCTION

Write function

PARAMETER	DESCRIPTION	POWER-ON INITIAL VALUE									
TINT	Adjusts hue. - 32°~ + 32°	0°									
DAC1/2	Controls 1 bit DAC. 0 : LOW, 1 : HIGH	LOW									
TOF-f0	Switches TOF peak frequency. (000) : TOF OFF, (001) : 0.8 fsc, (111) : 1.5 fsc	(100) CENTER									
TOR-Q	Switches TOF Q ; (000) : 0.6~(111) : 1.2	TOF OFF									
Y-DL	Switches Y-DL delay time ; (0) : OFF, (1) : ON (+ 80 ns)	OFF									
P/N ID	Switches PAL/NTSC identification sensitivity. (0) : LOW (Digital comb filter in use), (1) : Normal	LOW									
SUB CONTRAST	Adjusts sub contrast ; - 3.0 dB~ + 3.0 dB	0dB									
C-TRAP	Switches CHROMA trap ; (0) : OFF, (1) : ON	OFF									
HD-PHS	Switches HD output pulse phase ; (0) : PHASE-1, (1) : PHASE-2 (SCP)	PHASE-1									
SUB COLOR	Sub color ; - 5.3 dB~0 dB~ + 3.0 dB	0dB									
COLOR SYSTEM	Switches color system. <table border="1" style="margin-left: 20px;"> <tr> <td>(000) : AUTO</td> <td>(001) : 3NTSC</td> <td>(010) : 4NTSC</td> </tr> <tr> <td>(011) : PAL</td> <td>(100) : M-PAL</td> <td>(101) : N-PAL</td> </tr> <tr> <td>(101) : N-PAL</td> <td>(110) : SECAM</td> <td>(111) : TRINORMA</td> </tr> </table>	(000) : AUTO	(001) : 3NTSC	(010) : 4NTSC	(011) : PAL	(100) : M-PAL	(101) : N-PAL	(101) : N-PAL	(110) : SECAM	(111) : TRINORMA	(000) AUTO
(000) : AUTO	(001) : 3NTSC	(010) : 4NTSC									
(011) : PAL	(100) : M-PAL	(101) : N-PAL									
(101) : N-PAL	(110) : SECAM	(111) : TRINORMA									
Y BLACK LEVEL ADJ.	Adjusts Y black level ; - 75 mV~ + 65 mV	(1000)									
SW-OFT	Switches SW output offset ; Y : - 10 IRE & UV : + 60 mV ON/OFF (0) : OFF, (1) : ON	OFF									

PARAMETER	DESCRIPTION	POWER-ON INITIAL VALUE																																				
V-FREQ / AFC-G	Controls vertical frequency and horizontal free run.	(000) AUTO1																																				
	<table border="1"> <thead> <tr> <th></th> <th>V FREQUENCY</th> <th>AFC-Gain</th> <th>V pull-in range</th> </tr> </thead> <tbody> <tr> <td>(000)</td> <td>AUTO1 (50 / 60 Hz MODE)</td> <td>Normal</td> <td>224.5H~353H</td> </tr> <tr> <td>(001)</td> <td>60 Hz MODE</td> <td>Normal</td> <td>224.5H~297H</td> </tr> <tr> <td>(010)</td> <td>262.5H forced</td> <td>Free run</td> <td>—</td> </tr> <tr> <td>(011)</td> <td>312.5H forced</td> <td>Free run</td> <td>—</td> </tr> <tr> <td>(100)</td> <td>AUTO2 (50 / 60 Hz MODE)</td> <td>Normal</td> <td>32.5H~353H</td> </tr> <tr> <td>(101)</td> <td>60 Hz mode</td> <td>Normal</td> <td>32.5H~297H</td> </tr> <tr> <td>(110)</td> <td>262H forced</td> <td>Free run</td> <td>—</td> </tr> <tr> <td>(111)</td> <td>312H forced</td> <td>Free run</td> <td>—</td> </tr> </tbody> </table>			V FREQUENCY	AFC-Gain	V pull-in range	(000)	AUTO1 (50 / 60 Hz MODE)	Normal	224.5H~353H	(001)	60 Hz MODE	Normal	224.5H~297H	(010)	262.5H forced	Free run	—	(011)	312.5H forced	Free run	—	(100)	AUTO2 (50 / 60 Hz MODE)	Normal	32.5H~353H	(101)	60 Hz mode	Normal	32.5H~297H	(110)	262H forced	Free run	—	(111)	312H forced	Free run	—
			V FREQUENCY	AFC-Gain	V pull-in range																																	
	(000)		AUTO1 (50 / 60 Hz MODE)	Normal	224.5H~353H																																	
	(001)		60 Hz MODE	Normal	224.5H~297H																																	
	(010)		262.5H forced	Free run	—																																	
	(011)		312.5H forced	Free run	—																																	
	(100)		AUTO2 (50 / 60 Hz MODE)	Normal	32.5H~353H																																	
	(101)		60 Hz mode	Normal	32.5H~297H																																	
	(110)		262H forced	Free run	—																																	
(111)	312H forced	Free run	—																																			
B-Y / R-Y BLACK LEVEL ADJ.	Adjusts B-Y / R-Y black level ; - 68 mV~ + 68 mV	(100000) CENTER																																				
GP-PHS	Switches gate pulse phase ; (0) : Normal , (1) : - 200 ns (Ahead)	Normal																																				
Y-OFST	Switches Y output offset ; + 10 IRE : ON / OFF (0) : OFF, (1) : ON	OFF																																				
OUTPUT MODE	Switches SW output mode. Switches YUV / RGB (matrix coefficient) output. (00) : Y / U / V, (01) : RGB / PAL, (10) : RGB / NTSC1, (11) : RGB / NTSC2	(00) Y / U / V																																				

Read function

PARAMETER	DESCRIPTION
PORSET	Power-on reset. (0) : NORMAL, (1) RESISTER PRESET
COLOR SYSTEM	Color system. Received system (ID, no ID) (00) : B / W, (01) : SECAM, (10) : PAL, (11) : NTSC
X'tal	X'tal mode (00) : -, (01) : 4.43 (N), (10) : M, (11) : 3.58
V-FREQ	Vertical frequency ; (0) : 50 Hz, (1) : 60 Hz
V-STD	Decides vertical standard ; (0) : STANDARD, (1) : NON-STANDARD
H-LOCK	Decides horizontal lock ; (0) : LOCK, (1) : NON-LOCK
N-DET	Decides noise level ; (0) : Low, (1) : High
Y1-IN, U / V-IN	Outputs self diagnosis result. ; (0) : NG, (1) : OK

I²C BUS COMMUNICATION AND RECEPTION METHODS

Slave address : Slave addresses can be changed using the pin 23 voltage.

24H (Pin 23-GND)

A ₆	A ₅	A ₄	A ₃	A ₂	A ₁	A ₀	W/R
0	0	1	0	0	1	0	0/1

2CH (Pin 23-V_{CC})

A ₆	A ₅	A ₄	A ₃	A ₂	A ₁	A ₀	W/R
0	0	1	0	1	1	0	0/1

Slave address : 88H

A ₆	A ₅	A ₄	A ₃	A ₂	A ₁	A ₀	W/R
1	0	0	0	1	0	0	0/1

Start and end conditions

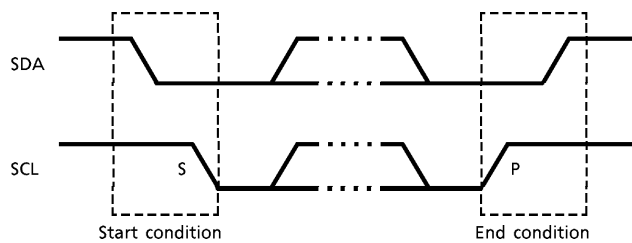

Bit transmission

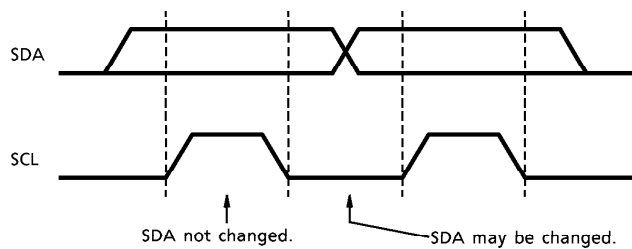

Acknowledgment

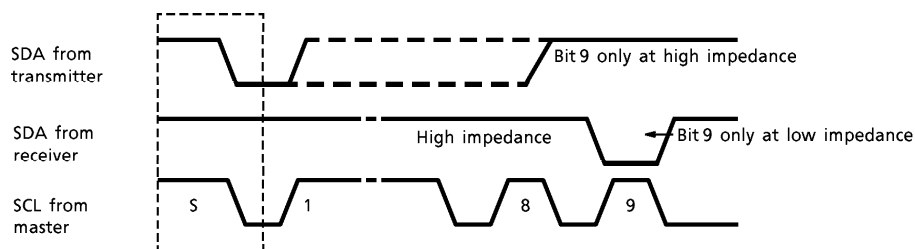

Data transmit format 1

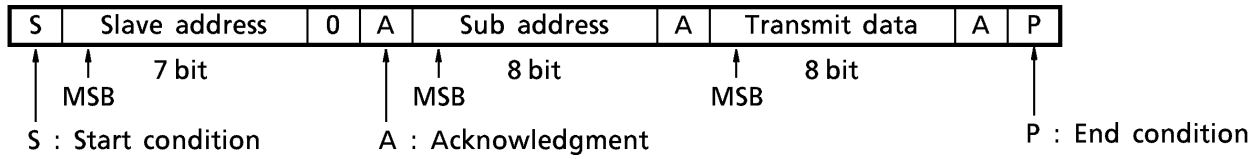

Data transmit format 2

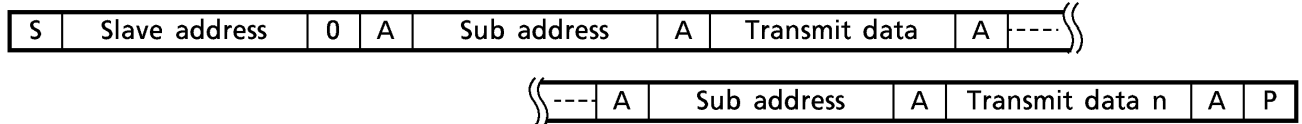

Data receive format

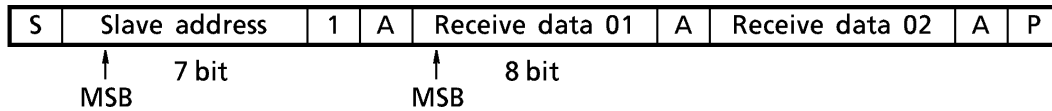

At data reception, the master transmitter changes to the receiver immediately after the first acknowledgment and the slave receiver changes to the transmitter.

The end condition is always generated by the master.

The detailed specifications conform to Philips I²C specifications.

Option data transmit format

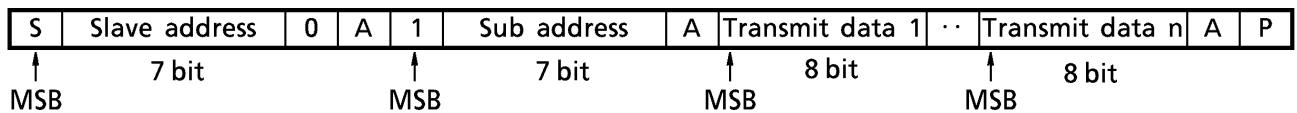

This transmission method automatically increments sub addresses starting from the specified sub address and sets data.

Purchase of TOSHIBA I²C components conveys a license under the Philips I²C Patent Rights to use these components in an I²C system, provided that the system conforms to the I²C standard Specification as defined by Philips.

MAXIMUM RATINGS (Ta = 25°C)

CHARACTERISTIC	SYMBOL	RATING	UNIT
Supply Voltage	V _{CCmax}	12	V
Input Pin Signal Voltage	e _{inmax}	9	V _{p-p}
Power Dissipation	PD (Note 1)	844	mW
Power Dissipation Reduction Rate	1 / Q _{ja}	6.75	mW / °C
Operating Temperature	T _{opr}	- 20~65	°C
Storage Temperature	T _{stg}	- 55~150	°C

(Note 1) See figure below.

(Note 2) Since the device is susceptible to surge, handle with care.

(Note 3) This IC is not proof enough against a strong E-M field by CRT which may cause function errors and / or poor characteristics.

Keeping the distance from CRT to the IC longer than 20 cm, or if cannot, placing shield metal over the IC, is recommended in an application.

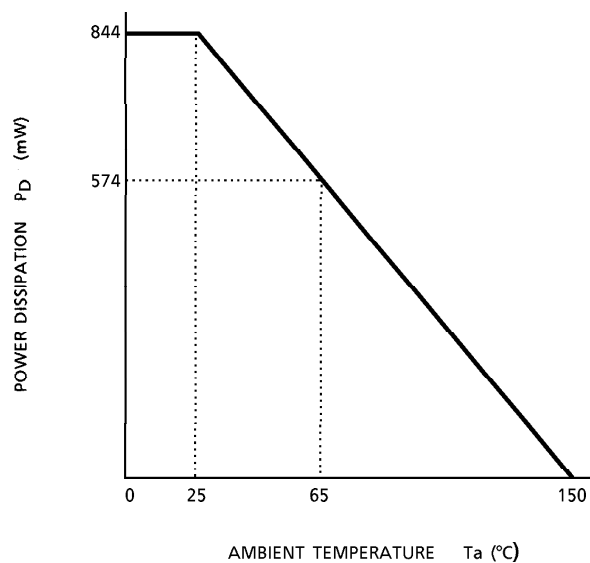

Fig. Power dissipation temperature reduction curve

RECOMMENDED USE CONDITIONS

CHARACTERISTIC	CONDITION	MIN.	TYP.	MAX.	UNIT
Supply Voltage	Pins 18, 19	8.5	9.0	9.5	V
	Pins 41, 42	4.7	5.0	5.3	
Pin 40 Y Input Signal Level	White 100%. Including sync signal	0.9	1.0	1.1	V _{p-p}
Pin 6 Chroma Input Signal Level	TOF : OFF, burst level	200	300	400	mV _{p-p}
	TOF : ON, burst level	100	200	300	
Pin 8 Sync Signal Input level	White 100%. Including sync signal	0.9	1.0	1.1	V _{p-p}
Pin 9 Sink Current	—	—	0.5	1.0	mA

ELECTRICAL CHARACTERISTICS (Unless otherwise specified, SYNC / SW
V_{CC} = 9 V, DAC / C V_{CC} = 5 V, Ta = 25°C ± 3°C)
Current dissipation

PIN No.	PIN NAME	SYMBOL	TEST CIR-CUIT	MIN.	TYP.	MAX.	UNIT
18	SYNC V _{CC}	I _{CC1}	—	24	35	46	mA
19	SW V _{CC}	I _{CC2}	—				
41	DAC V _{CC}	I _{CC3}	—	13	19	25	
42	C V _{CC}	I _{CC4}	—				

PIN VOLTAGE

PIN No.	PIN NAME	SYMBOL	TEST CIR-CUIT	MIN.	TYP.	MAX.	UNIT
1	4.43 MHz X'tal	V1	—	3.60	4.00	4.40	V
2	N-X'tal	V2	—	3.60	4.00	4.40	
3	3.58 MHz X'tal	V3	—	3.60	4.00	4.40	
6	C input	V6	—	1.30	1.75	2.20	
7	V-SEP	V7	—	5.10	5.50	5.90	
12	32 fH VCO	V12	—	5.30	5.70	6.10	
20	Y / G output	V20	—	3.90	4.30	4.70	
21	B-Y / B output	V21	—	3.90	4.30	4.70	
22	R-Y / R output	V22	—	3.90	4.30	4.70	
25	Y2 input	V25	—	5.30	5.70	6.10	
26	B-Y2 input	V26	—	5.30	5.70	6.10	
27	R-Y2 input	V27	—	5.30	5.70	6.10	
29	Y1 input	V29	—	5.30	5.70	6.10	
30	B-Y1 input	V30	—	5.30	5.70	6.10	
31	R-Y1 input	V31	—	5.30	5.70	6.10	
37	Y output	V37	—	1.60	2.00	2.40	
40	Y input	V40	—	2.10	2.50	2.90	

AC CHARACTERISTICS

Video block

CHARACTERISTIC	SYMBOL	TEST CIR-CUIT	TEST CONDITION	MIN.	TYP.	MAX.	UNIT
Y Input Clamp Voltage	VYI	—	Y input-AC GND	2.1	2.4	2.8	V
Y Input to Y Output AC Gain	GYs	—	(Note V1)	-0.13	0	0.13	dB
	GYt	—		-0.13	0	0.13	
Y Input to Y Output Frequency Bandwidth	GfY	—	-3 dB	8	10	—	dB
TRAP Filter Characteristic	GTC3	—	fO = 3.579545 MHz	—	-25	-13	
	GTC4	—	fO = 4.433619 MHz	—	-25	-13	
Y Input Dynamic Range	VD	—	Sub contrast : min.	1.3	1.6	—	V _{p-p}
Y Input to Y Output Transmission Characteristic 1	TYa	—	Black and white, Y-DL : OFF	255	295	335	ns
	TYb	—	Black and white, Y-DL : ON	335	375	415	
Y Input to Y Output Transmission Characteristic 2	TY3	—	3.58 NTSC, Y-DL : OFF	255	295	335	
	TY4	—	4.43 PAL, Y-DL : OFF	255	295	335	
	TYS	—	SECAM, Y-DL : OFF	445	495	535	
Sub Contrast Range	Δ VSU +	—	20 log (Data max./data center)	2.5	3.0	3.5	dB
	Δ VSU -	—	20 log (Data max./data center)	-3.5	-3.0	-2.5	
Y Output Offset Amount	VYO	—	(Note V2)	60	95	130	mV

Chroma block

CHARACTERISTIC	SYMBOL	TEST CIRCUIT	TEST CONDITION	MIN.	TYP.	MAX.	UNIT
ACC Characteristics	F600	—	(Note C1)	300	360	420	mV _{p-p}
	F300	—		300	360	420	
	F30	—		300	360	420	
	F10	—		170	245	290	
	A	—		0.95	1.00	1.05	—
Sub Color Control Characteristic	es +	—	20 log (Data max./data center)	2.0	3.0	4.0	dB
	es -	—	20 log (Data max./data center)	-7.4	-5.3	-2.4	
APC Frequency Control Sensitivity	$\beta 3$	—	(Note C2)	0.5	1.65	2.2	Hz / mV
	$\beta 4$	—		0.5	1.65	2.2	
	βM	—		0.5	1.65	2.2	
APC Pull-In Range	f3ph	—	At 3.58 NTSC, upper side	250	600	2000	Hz
	f3pl	—	At 3.58 NTSC, lower side	-2000	-1400	-250	
	f4ph	—	At 4.43 PAL, upper side	250	600	2000	
	f4pl	—	At 4.43 PAL, lower side	-2000	-950	-250	
	fMph	—	At M-PAL, upper side	250	600	2000	
	fMpl	—	At M-PAL, lower side	-2000	-1100	-250	
APC Hold Range	f3hh	—	At 3.58 NTSC, upper side	250	600	2000	Hz
	f3hl	—	At 3.58 NTSC, lower side	-2000	-1400	-250	
	f4hh	—	At 4.43 PAL, upper side	250	600	2000	
	f4hl	—	At 4.43 PAL, lower side	-2000	-950	-250	
	fMhh	—	At M-PAL, upper side	250	600	2000	
	fMhl	—	At M-PAL, lower side	-2000	-1100	-250	
fsc Free-Run Frequency	fO3	—	fO = 3.579545 MHz	-200	0	200	V _{p-p}
	fO4	—	fO = 4.433619 MHz	-200	0	200	
	fOM	—	fO = 3.575611 MHz	-200	0	200	
fsc Output Amplitude	f3c	—	At 3.58 NTSC input	0.45	0.75	0.95	V
	f4c	—	At 4.43 PAL input	0.50	0.65	0.80	
	fMc	—	At M-PAL input	0.45	0.75	0.95	
fsc Output DC Level	V44a	—	At 3.58 NTSC input	2.9	3.2	3.5	mV _{p-p}
	V44b	—	At other than 3.58 NTSC input	1.15	1.55	1.75	
Color Difference Output Level	vR _{NUV}	—	3.58 NTSC - UV mode,	300	360	420	mV _{p-p}
	vB _{NUV}	—	B : C = 1 : 1	280	340	400	
	vR _{NCbCr}	—	3.58 N - CbCr mode,	215	272	320	
	vB _{NCbCr}	—	B : C = 1 : 1	280	340	400	
	vR _p	—	4.43 PAL,	315	380	440	
	vB _p	—	B : C = 1 : 1	315	380	440	
Relative Amplitude	vR / B _{UV}	—	3.58 NTSC - UV mode	0.94	1.00	1.15	—
	vR / B _{CbCr}	—	3.58 N - CbCr mode	0.94	1.00	1.15	
	vR / B _{PAL}	—	4.43 PAL	0.94	1.00	1.15	

CHARACTERISTIC	SYMBOL	TEST CIR-CUIT	TEST CONDITION	MIN.	TYP.	MAX.	UNIT	
Demodulation Angle	θ_{BNUV}	—	3.58 NTSC – UV mode, TINT ; center	0	3	8	°	
	θ_{RNUV}	—		90	93	96		
	θ_{BNCbCr}	—	3.58 N – CbCr mode, TINT ; center	0	3	8		
	θ_{RNCbCr}	—		90	93	96		
	θ_{Bp}	—	4.43 PAL	-3.0	0	5.5		
	θ_{Rp}	—		87	90	95		
Color Difference Output Tint Adjustment Characteristic	θ_{UVMAX}	—	UV Mode, TINT ; max.	29	32	35	°	
	θ_{UVMIN}	—	UV Mode, TINT ; min.	-35	-32	-29		
	$\theta_{CbCrMAX}$	—	CbCr Mode, TINT ; max.	29	32	35		
	$\theta_{CbCrMIN}$	—	CbCr Mode, TINT ; min.	-35	-32	-29		
Residual Carrier Level	ve	—	fsc level	—	1.9	4.0	mV _{p-p}	
Residual Harmonic Level	vHe	—	(fsc x 2) level	—	1.9	4.0		
1HDL CONT Output DC Level Change	VDLP	—	PAL signal input	4.0	4.3	4.6	V	
	VDLS	—	SECAM signal input	2.2	2.5	2.8		
	VDLN	—	NTSC signal input	0	0.1	0.2		
Sand Castle Pulse Wave High Value	SCH	—	CP level	7.6	7.9	8.2		
	SCM	—	HP level	4.05	4.3	4.55		
	SCL	—	VP level	2.25	2.5	2.75		
SECAM ID Output DC Level	SEN	—	(Note C3)	3.4	3.7	4.0	mV _{p-p}	
	SEP	—		3.4	3.7	4.0		
	SES	—		0.4	0.7	1.0		
NTSC Ident Sensitivity	vNCL	—	(Note C4)	2.0	2.9	4.0		mV _{p-p}
	vNCH	—		0.5	1.8	4.0		
	vNBL	—		1.7	2.7	5.8		
	vNBH	—		0.3	1.6	3.6		
PAL Ident Sensitivity	vPCL	—	(Note C5)	1.5	4.5	6.5	mV _{p-p}	
	vPCH	—		1.0	2.8	3.1		
	vPBL	—		1.5	4.1	6.1		
	vPBH	—		1.0	2.5	4.5		
TOF Characteristic	GFH3	—	(Note C6)	14.0	16.5	19.0		dB
	GFC3	—		12.5	15.0	17.5		
	GFL3	—		10.5	13.0	15.5		
	GFH4	—		15.5	18.0	20.5		
	GFC4	—		14.0	16.5	19.0		
	GFL4	—		12.0	14.5	17.0		

Switch block

CHARACTERISTIC	SYMBOL	TEST CIRCUIT	TEST CONDITION	MIN.	TYP.	MAX.	UNIT
Y Gain (Through Mode)	GY1	—	(Note S1)	-1.0	0	1.0	dB
	GY2	—		-1.0	0	1.0	
Color Difference Gain (Through Mode)	GBY1	—	(Note S2)	-1.0	0	1.0	
	GRY1	—		-1.0	0	1.0	
	GBY2	—		-1.0	0	1.0	
	GRY2	—		-1.0	0	1.0	
Y Gain (Matrix Mode)	GY1GP	—	(Note S3)	-1.0	0	1.0	
	GY1GN1	—		-1.0	0	1.0	
	GY1GN2	—		-1.0	0	1.0	
	GY1BP	—		-1.0	0	1.0	
	GY1BN1	—		-1.0	0	1.0	
	GY1BN2	—		-1.0	0	1.0	
	GY1RP	—		-1.0	0	1.0	
	GY1RN1	—		-1.0	0	1.0	
Color Difference Gain (Matrix Mode)	GGYP	—	(Note S4)	-0.6	0.6	1.6	
	GGYN1	—		-0.6	0.6	1.6	
	GGYN2	—		-1.0	0	1.0	
	GBYP	—		8.9	9.9	10.9	
	GBYN1	—		7.5	8.5	9.5	
	GBYN2	—		7.5	8.5	9.5	
	GRYP	—		3.9	4.9	5.9	
	GRYN1	—		5.6	6.6	7.6	
R-Y Relative Phase	θ_{RP}	—	RGB / PAL Mode	87	90	93	°
	θ_{RN1}	—	RGB / NTSC1 Mode	89	92	95	
	θ_{RN2}	—	RGB / NTSC2 Mode	93	96	99	
R-Y Relative Amplitude	vPR / B	—	RGB / PAL Mode	0.53	0.56	0.59	—
	vN1R / B	—	RGB / NTSC1 Mode	0.77	0.80	0.83	
	vN2R / B	—	RGB / NTSC2 Mode	0.65	0.68	0.71	
G-Y Relative Phase	θ_{GP}	—	RGB / PAL Mode	234	237	240	°
	θ_{GN1}	—	RGB / NTSC1 Mode	237	240	243	
	θ_{GN2}	—	RGB / NTSC2 Mode	237	240	243	
G-Y Relative Amplitude	vPG / B	—	RGB / PAL Mode	0.31	0.34	0.37	—
	vN1G / B	—	RGB / NTSC1 Mode	0.37	0.40	0.43	
	vN2G / B	—	RGB / NTSC2 Mode	0.34	0.37	0.40	

CHARACTERISTIC	SYMBOL	TEST CIR-CUIT	TEST CONDITION	MIN.	TYP.	MAX.	UNIT
Switch Output Switch Offset	ΔVY	—	—	—	0	50	mV
	ΔVB	—	—	—	0	50	
	ΔVR	—	—	—	0	50	
Switch Output Offset Amount	ΔVYO	—	(Note S5)	-85	-75	-65	
	ΔVBO	—		61	68	75	
	ΔVRO	—		61	68	75	
Y/G Output Black Level Range	$\Delta VYB +$	—	(Note S6)	59	65	71	
	$\Delta VYB -$	—		-82	-75	-68	
	$\Delta VYO +$	—		59	65	71	
	$\Delta VYO -$	—		-82	-75	-68	
B-Y/G Output Black Level Range	$\Delta VBB +$	—	(Note S7)	61	68	75	
	$\Delta VBB -$	—		-75	-68	-61	
	$\Delta VBO +$	—		61	68	75	
	$\Delta VBO -$	—		-75	-68	-61	
R-Y/G Output Black Range	$\Delta VRB +$	—	(Note S8)	61	68	75	
	$\Delta VRB -$	—		-75	-68	-61	
	$\Delta VRO +$	—		61	68	75	
	$\Delta VRO -$	—		-75	-68	-61	
Smoothing Level	VYSM	—	Blanking period voltage	4.0	4.3	4.6	V
	VBSM	—		4.0	4.3	4.6	
	SRSM	—		4.0	4.3	4.6	
Switch Output Dynamic Range	DTH	—	Through mode	1.5	2.3	—	V_{p-p}
	DMT	—	Matrix mode	0.9	1.2	—	
Inter-Input Crosstalk	GCR	—	Crosstalk between inputs	—	-50	-40	dB

Sync processor block

CHARACTERISTIC	SYMBOL	TEST CIR-CUIT	TEST CONDITION	MIN.	TYP.	MAX.	UNIT
32 fH VCO Oscillation Start Voltage	V _{VCO}	—	Pin 18 voltage	3.7	4.0	4.3	V
Horizontal Free-Run Frequency	f50HO	—	AUTO mode	15.455	15.625	15.795	kHz
	f60HO	—	60 Hz mode	15.564	15.734	15.904	
Horizontal Oscillation Frequency Range	fHmin	—	Pin 10 ; 10 k Ω - V _{CC}	14.700	15.000	15.300	
	fHmax	—	Pin 10 ; 10 k Ω - GND	16.500	16.700	16.900	
Horizontal Oscillation Frequency Control Sensitivity	β _H	—	—	2.3	2.8	3.3	kHz / V
Horizontal Sync Phase	Sph1	—	(Note D1)	0.30	0.40	0.50	μ s
	Sph2	—		0.11	0.21	0.31	
External Pulse Input Threshold (Pin 17)	CPV17	—	Clamp pulse	3.2	3.5	3.8	V
	HPV17	—	Horizontal blanking	0.7	1.0	1.3	
Horizontal Blanking Start Phase	HPs	—	(Note D2)	4.1	4.4	4.7	μ s
Horizontal Blanking Width	HPw	—		11.0	11.5	12.0	
Gate Pulse Start Phase	GPs	—	(Note D3)	2.8	3.0	3.2	
Gate Pulse Width	GPw	—		1.8	2.0	2.2	
Horizontal Blanking Pulse Start Phase	HPs	—	(Note D4)	3.8	4.0	4.2	μ s
Horizontal Blanking Pulse Width	HPw	—		9.5	10.0	10.5	
HD Output Start Phase	HDs	—	(Note D5)	-0.2	0	0.2	
HD Output Pulse Width	HDw	—		1.6	1.8	2.0	
HD Amplitude	VHD	—		4.7	5.0	5.3	V
Vertical Blanking Pulse Start Phase	VP50s1	—	(Note D6)	46	48	50	μ s
	VP60s1	—		46	48	50	
Vertical Blanking Pulse Width	VP50s2	—		—	23	—	H
	VP60s2	—		—	21	—	
Vertical Free-Run Frequency	f50vo	—	AUTO mode (353H)	40	45	50	Hz
	f60vo	—	60 Hz mode (297H)	48	53	58	
Vertical Output Voltage	Vvh	—	Pin 13 high voltage	4.7	5.0	5.3	V
	Vvl	—	Pin 13 low voltage	—	0	0.3	

CHARACTERISTIC	SYMBOL	TEST CIR-CUIT	TEST CONDITION	MIN.	TYP.	MAX.	UNIT
Vertical Output Pulse Width	Td	—	(Note D7)	42	44	46	μs
	Tw	—		—	8	—	
Vertical Pull-In Range (1)	fPL1	—	(Note D8)	—	224.5	—	H
	fPH1	—		—	353	—	
Vertical Pull-In Range (2)	fPL2	—		—	32.5	—	
	fPH2	—		—	353	—	
Vertical Pull-In Range (3)	fPL3	—		—	224.5	—	
	fPH3	—		—	297	—	
Vertical Pull-In Range (4)	fPL4	—		—	32.5	—	
	fPH4	—		—	297	—	
Address Switch Threshold Value	Vadd	—	Pin 23 voltage	0.5	0.65	0.8	V

TEST METHODS (Unless otherwise specified, SYNC/SW V_{CC} = 9 V, DAC/C V_{CC} = 5 V, preset bus data, T_a = 25°C ± 3°C)
Video block

NOTE	CHARACTERISTIC	TEST CONDITION							TEST METHOD	
		SUB ADDRESS & DATA				SW MODE				
		00	01	02	03	05	SW1	SW2		SW12
V1	Y Input to Y Output AC Gain	80	80	80	80	80	B	A	A	(1) Input signal 2 to Y input (Pin 40) and Yin2 input. (f ₀ = 100 kHz, picture period amplitude = 0.2 V _{p-p}) (2) Change the sub address (02) data to TRAP-OFF (80h) and TRAP-ON (84h) and perform the following : (3) Measure the picture period amplitude (v37) of the Y output (Pin 37) and determine the gain from Y input. GYs, GYt = 20 log (v37/0.2) (GYs ; TRAP-OFF, GYt ; TRAP-ON)
V2	Y Output Offset Amount	80	0	80	80	80	B	A	A	(1) Input signal 2 to Y input (Pin 40) and Yin2 input. (f ₀ = 100 kHz, picture period amplitude = 0.2 V _{p-p}) (2) Set the sub address (01) data to 00 and measure the minimum potential (VYO1) of the Y output (Pin 37) picture period amplitude. (3) Set the sub address (05) data to Y-OFST-ON (81), measure the minimum potential (VYO2) of the Y output picture period amplitude, and determine the difference from VYO1. VYO = VYO2 - VYO1

Chroma block

NOTE	CHARACTERISTIC	TEST CONDITION							TEST METHOD
		SUB ADDRESS & DATA							
		00	01	02	03	05	SW1	SW MODE	
C1	ACC Characteristics	80	80	80	80	80	B	—	(1) Input 3.58-NTSC signal 1 rainbow signal (Burst : chroma = 1 : 1) to the chroma input (Pin 6). (2) Measure the amplitude, F10, F30, F300, and F600, of the B-Y output (Pin 47) when the amplitude of the chroma input signal is set to 10, 30, 300, and 600 mV _{p-p} . (3) Calculate A = F30 / F300.
C2	APC Frequency Control Sensitivity	80	80	80	81 or 83 or 84	80 or 81	B	—	(1) Connect the chroma input pin (Pin 6) to GND via a capacitor. (2) Change the sub address (03) data to (81h), (83h), and (84h) and perform the following for each. (3) Connect external power source (V4) to the APC filter (Pin 4). (4) Vary the voltage of external power source (V4) and measure the Fsc output (Pin 44) using a frequency counter. (5) Measure the free-run sensitivity β for the (V4 + 100 mV) near fc. (3.58NTSC ; β 3, 4.43 ; PAL ; 4 β ; M-PAL ; β M)
C3	SECAM ID Output DC Level	80	80	80	81 or 83 or 84	80	B	—	(1) Connect the chroma input pin (Pin 6) to GND via a capacitor. (2) Change the sub address (03) data to (81h), (83h), and (84h) and measure the output DC level of the SECAM ID (Pin 46). 3.58 NTSC mode (81h) ; SEN 4.43 PAL mode (83h) ; SEP SECAM mode (84h) ; SES
C4	NTSC Ident Sensitivity	80 or 81	80	80	80	80	A	—	(1) Input 3.58-NTSC signal 1 rainbow signal (Burst : chroma = 1 : 1) to the chroma input (Pin 6). (2) While monitoring READ BUS "COLOR", perform the following with BUS "P/N-ID" data = 1 and 0. (3) Increase the amplitude of the input signal from 0 mV _{p-p} and measure the amplitude at mode change to 3.58 NTSC mode. (Normal (1) ; vNCL, High (0) ; vNCH) (4) Decrease the amplitude of the input signal from 100 mV _{p-p} and measure the amplitude at mode change to 3.58 NTSC mode. (Normal (1) ; vNBL, High (0) ; vNBH)

TA1270BF-25

(Unless otherwise specified, SYNC/SW V_{CC} = 9 V, DAC/C V_{CC} = 5 V, preset bus data, T_a = 25°C ± 3°C)

NOTE	CHARACTERISTIC	TEST CONDITION					TEST METHOD				
		SUB ADDRESS & DATA	SW MODE	00	01	02		03	05	SW1	
C5	PAL Ident Sensitivity	80	80 or 81	80	80	80	80	A	—	—	(1) Input 4.43 PAL signal 1 rainbow signal (Burst : chroma = 1 : 1) to the CHROMA input (Pin 6). (2) While monitoring the READ BUS "COLOR", perform the following with BUS "P/N-ID" data = 1 and 0. (3) Increase the amplitude of the input signal from 0 mV _{p-p} and measure the amplitude at mode change to 4.43 PAL mode. (Normal (1) ; vPCL, High (0) ; vPCH) (4) Decrease the amplitude of the input signal from 100 mV _{p-p} and measure the amplitude at mode change to 4.43 PAL mode. (Normal (1) ; vPBL, High (0) ; vPBH)
C6	TOF Characteristics	80	83	80	80	80	81 or 83	A	—	—	(1) Input f _{sc} signal to the chroma input (Pin 6). (signal amplitude = 10 mV _{p-p} , f01 = 3.579545 MHz, f02 = 4.433619 MHz) (2) Set sub address (01) data to (38h). With f01, set sub address (03) data to (81h) ; with f01, to (83h). Insert a 1.5 kΩ resistor between R-Y output (Pin 48) and V _{CC} (5 V). Monitor R-Y output (Pin 48) and perform the following. (3) Measure the output amplitude with f0 and calculate the gain from the input. (f01 ; GFC3, f02 ; GFC4) (4) Measure the output amplitude with f0 ± 500 kHz and calculate the gain from the input. (f01 + 500 kHz ; GFH3, f01 - 500 kHz ; GFL3, f02 + 500 kHz ; GFH4, f02 - 500 kHz ; GFL4)

Switching block (Unless otherwise specified, SYNC/SW VCC = 9 V, DAC/C VCC = 5 V, preset bus data, Ta = 25°C ± 3°C)

NOTE	CHARACTERISTIC	TEST CONDITION						TEST METHOD	
		SUB ADDRESS & DATA			SW MODE				
		00	01	02	SW2	SW6	SW8		SW9
S1	Y Gain (Through Mode)	80	80	80	A	B or A	—	A or B	(1) Input signal 2 to Yin2 input. (f0 = 100 kHz, picture period amplitude = 0.2 Vp-p) (2) Apply DC = 5 V to Ys input (Pin 32). (3) Input signal 2 to Y1 input (Pin 29). (4) Measure the output amplitude of Y/G output (Pin 20) and calculate the gain from the input. (5) Input signal 2 to Y2 input (Pin 25), set Ys input (Pin 32) DC = 0 V, and repeat (3) and (4) above. (Y1~Y/G ; GY1, Y2~Y/G ; GY2)
					SW10	SW11	SW14	SW16	
S2	Color Difference Gain (Through Mode)	80	80	81 or 82 or 83	A	A or B	B or A	B or A	(1) Same as (1) and (2) for S1 above. (2) Input signal 2 to B-Y1 input (Pin 30) and input +90° phase signal of signal 2 to R-Y1 input (Pin 30). (3) Measure the amplitude of the B-Y/B output and the R-Y/R output and calculate the gain from the input. (4) Input signal 2 to B-Y2 input (Pin 26) and input +90° phase signal of signal 2 to the R-Y2 input (Pin 27). (5) Set the Ys input pin DC = 0 V and repeat (4) above. (B-Y1~B-Y/B ; GBY1, R-Y1~R-Y/R ; GRY1 B-Y2~B-Y/B ; GBY2, R-Y2~R-Y/R ; GRY2)
					SW10	SW11	SW14	SW16	
S3	Y Gain (Matrix Mode)	80	80	81 or 82 or 83	A	B or A	—	A or B	(1) Same as (1) and (2) for S1 above. (2) Change the sub address (06) data to PAL (81h), NTSC1 (82h), and NTSC2 (83h), perform the following. (3) Input signal 2 to Y1 input (Pin 29), measure the amplitude of Y/G output, B-Y/B output, R-Y/R output, and calculate the gain from the input. (Y1~Y/G : PAL ; GY1GP, NTSC1 ; GY1GN1, NTSC2 ; GY1GN2 Y1~B-Y/B : PAL ; GY1BP, NTSC1 ; GY1BN1, NTSC2 ; GY1BN2 Y1~R-Y/B : PAL ; GY1RP, NTSC1 ; GY1RN1, NTSC2 ; GY1RN2)
					SW10	SW11	SW14	SW16	

TA1270BF-27

(Unless otherwise specified, SYNC/SW VCC = 9 V, DAC/C VCC = 5 V, preset bus data, Ta = 25°C ± 3°C)

NOTE	CHARACTERISTIC	TEST CONDITION						TEST METHOD				
		SUB ADDRESS & DATA			SW MODE							
		00	01	02	SW2	SW6	SW8		SW9			
S4	Color Difference Gain (Matrix Mode)	80	83	81 or 82 or 83	A	A	B	B	(1) Same as (1) and (2) for S2 above. (2) Change the sub address (05) data to PAL (81h), NTSC1 (82h), and NTSC2 (83h), perform the following. (3) Measure the amplitude of Y/G output, B-Y/B output, R-Y/R output, then calculate the gain from the input. (Y1~Y/G : PAL ; GGYP, NTSC1 ; GGYN1, NTSC2 ; GGYN2 Y1~B-Y/B : PAL ; GBYP, NTSC1 ; GBYN1, NTSC2 ; GBYN2 Y1~R-Y/R : PAL ; GRYP, NTSC1 ; GRYN1, NTSC2 ; GRYN2)			
					SW10	SW11	SW14	SW16		A	A	—
					A	A	A	—		—	—	—
S5	Switch Output Offset Amount	80	80	80	SW2	SW6	SW7	SW8	(1) Input signal 2 to Yin2. (2) Apply DC = 5 V to Ys input (Pin 32). (3) Change the sub address (04) data from (80h) to (88h) and measure DC variation ΔVYO, ΔVBO, and ΔVRO of Y/G output, B-Y/B output, and R-Y/R output picture period.			
					A	B	B	B				
					SW14	—	—	—				
S6	Y/G Output Black Level Range	Vari- able	80	80	SW2	SW6	SW7	SW8	(1) Same as (1) and (2) for S1 above. (2) Change the sub address (04) data from (80h) to (F0h) and measure the DC variation ΔVYB+ of the Y/G output (Pin 20) picture period. Also change the data from (80h) to (00h) and measure the DC variation ΔVYB-. (3) Change the sub address (04) data from (88h) to (F8h) and from (88h) to (08h), then measure ΔVYO+ and ΔVYO-.			
					A	B	B	B				
					SW14	—	—	—				
S7	B-Y/B Output Black Level Range	80	80	Vari- able	SW2	SW6	SW7	SW8	(1) Same as (1) and (2) for S1 above. (2) Change the sub address (06) data from (80h) to (00h) and measure the DC variation ΔVBB+ of the B-Y/B output (Pin 21) picture period. Also change the data from (80h) to (F8h) and measure the DC variation ΔVBB-. (3) Change the sub address (04) data to (88h) and measure ΔVBO+ and ΔVBO- same as (2) above.			
					A	B	B	B				
					SW14	—	—	—				
S8	R-Y/R Output Black Level Range	80	Vari- able	80	SW2	SW6	SW7	SW8	(1) Same as (1) and (2) for S1 above. (2) Change the sub address (05) data from (80h) to (00h) and measure the DC variation ΔVRB+ of the R-Y/R output (Pin 22) picture period. Also change the data from (80h) to (F8h) and measure the DC variation ΔVRB-. (3) Change the sub address (04) data to (88h) and measure ΔVRO+ and ΔVRO- same as (2) above.			
					A	B	B	B				
					SW14	—	—	—				

TA1270BF—28

(Unless otherwise specified, SYNC/SW VCC = 9 V, DAC/C VCC = 5 V, preset bus data, Ta = 25°C ± 3°C)

NOTE	CHARACTERISTIC	TEST CONDITION				TEST METHOD
		SW MODE			TP32	
		SW2	SW4	SW5		
D1	Horizontal Sync Phase	A	B	A	5V	(1) Input signal in the figure below from TG7 to Y2in. (2) Measure the pin 10 waveform phase difference Sph1 in relation to the TP8 waveform. (3) Set the sub address (05) D1 as 1 and measure Sph2 same as (1) above.
		A	B	A	5V	(1) Same as (1) for D1. (2) Measure phase differences HPs and HPw for pin 10 and pin 21, respectively.
D2	Horizontal Blanking Start Phase	A	B	A	5V	(1) Same as (1) for D1. (2) Measure the pin 15 waveform phase difference GPs in relation to the pin 10 waveform and measure pulse width GPw.
	Horizontal Blanking Pulse Width	A	B	A	5V	(1) Same as (1) for D1. (2) Measure HPs and HPw same as (2) for D3.
D3	Gate Pulse Start Phase	A	B	A	5V	(1) Same as (1) for D1. (2) Measure the pin 14 waveform phase difference HDs in relation to the pin 10 waveform and measure pulse width HDw and amplitude VHD.
	Gate Pulse Width	A	B	A	5V	(1) Same as (1) for D1. (2) Measure VP50s1 in relation to the pin 8 waveform and measure pulse width VP50s2.
D4	Horizontal Blanking Pulse Start Phase	A	B	A	5V	(1) Input 50Hz CVBS signal to Y2in. (2) Measure the pin 15 waveform phase difference VP50s1 in relation to the pin 8 waveform and measure pulse width VP50s2.
	Horizontal Blanking Pulse Width	A	B	A	5V	(3) Input 60Hz CVBS signal to Y2Yin. (4) Measure VP60s1 and VP60s2 same as (2) above.
	HD Output Start Phase	A	B	A	5V	(1) Input 60Hz CVBS signal to Y2in. (2) Measure the delay Td of the pin 13 vertical pulse in relation to the pin 8 vertical signal and measure the pulse width Tw.
D5	HD Output Pulse Width	A	B	A	5V	(1) Input 60Hz CVBS signal to Y2in. (2) Measure the delay Td of the pin 13 vertical pulse in relation to the pin 8 vertical signal and measure the pulse width Tw.
	HD Output Amplitude	A	B	A	5V	(1) Input 60Hz CVBS signal to Y2in. (2) Measure the delay Td of the pin 13 vertical pulse in relation to the pin 8 vertical signal and measure the pulse width Tw.
D6	Vertical Blanking Pulse Start Phase	A	B	A	5V	(1) Input 60Hz CVBS signal to Y2in. (2) Measure the delay Td of the pin 13 vertical pulse in relation to the pin 8 vertical signal and measure the pulse width Tw.
	Vertical Blanking Pulse Width	A	B	A	5V	(1) Input 60Hz CVBS signal to Y2in. (2) Measure the delay Td of the pin 13 vertical pulse in relation to the pin 8 vertical signal and measure the pulse width Tw.
D7	Vertical Pulse Width	A	B	A	5V	(1) Input 60Hz CVBS signal to Y2in. (2) Measure the delay Td of the pin 13 vertical pulse in relation to the pin 8 vertical signal and measure the pulse width Tw.

TA1270BF-29

(Unless otherwise specified, SYNC/SW VCC = 9 V, DAC/C VCC = 5 V, preset bus data, Ta = 25°C ± 3°C)

NOTE	CHARACTERISTIC	TEST CONDITION				
		SW MODE			TEST METHOD	
		SW2	SW4	SW5		TP32
D8	Vertical Pull-In Range (1)	A	B	A	5V	(1) Input 50 Hz CVBS signal to Y2in. (2) Change the input signal vertical frequency in 0.5 H steps and measure the pull-in ranges fPL1 and fPH1. (3) Set the sub address (04) D2/D1/D0 to (100) and measure fPL2 and fPH2 same as in (2). (4) Input 60 Hz CVBS signal to Y2in and set the sub address (04) D2/D1/D0 to (001). (5) Change the input signal vertical frequency in 0.5 H steps and measure the pull-in ranges fPL3 and fPH3. (6) Set the sub address (04) D2/D1/D0 to (101) and measure fPL4 and fPH4 same as (5).
	Vertical Pull-In Range (2)					
	Vertical Pull-In Range (3)					
	Vertical Pull-In Range (4)					

TEST SIGNALS

① Signal 1 (Rainbow signal)

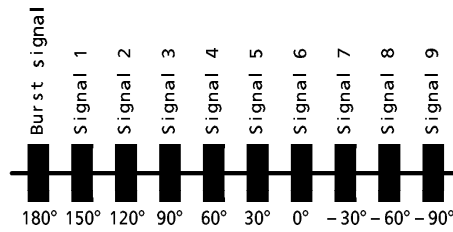

② Signal 2

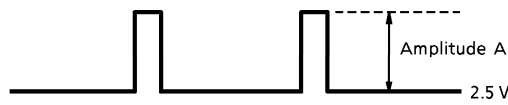

③ Signal 3

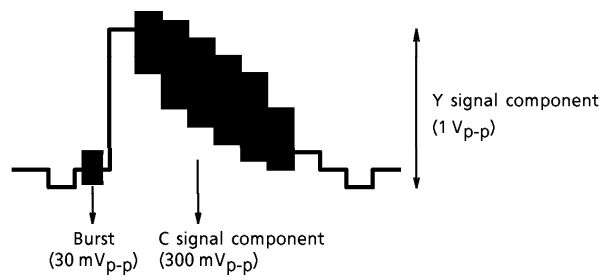

④ Signal 4

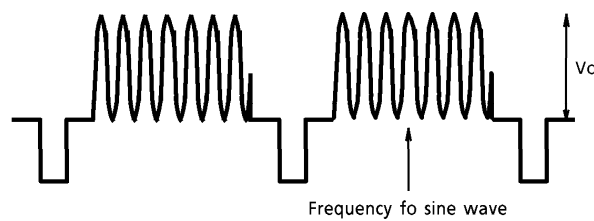

(Note D6) VERTICAL BLANKING PULSE

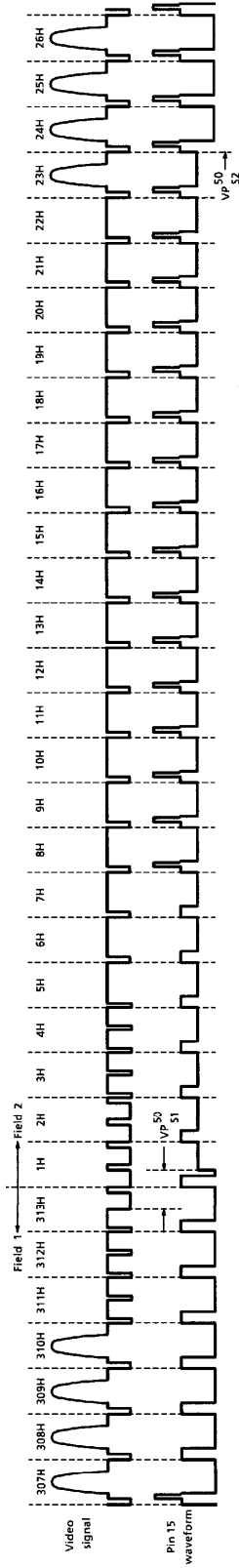
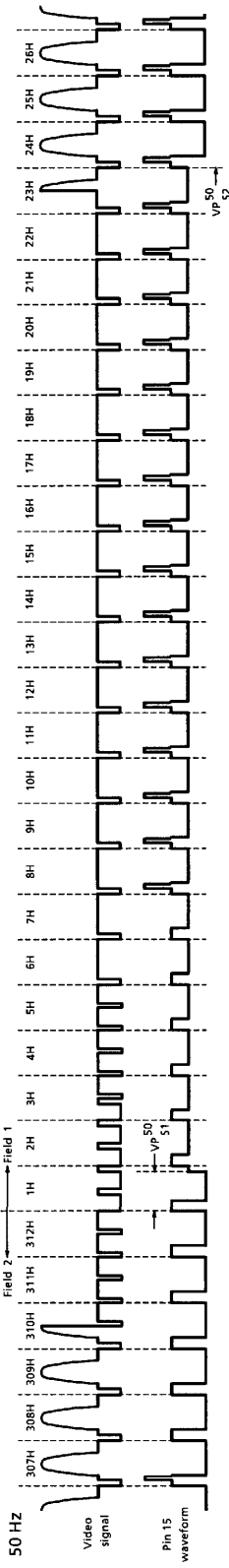

60 Hz

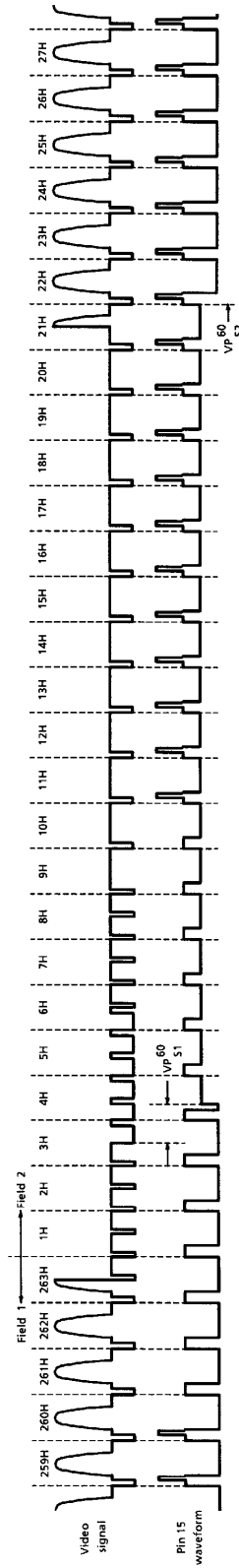
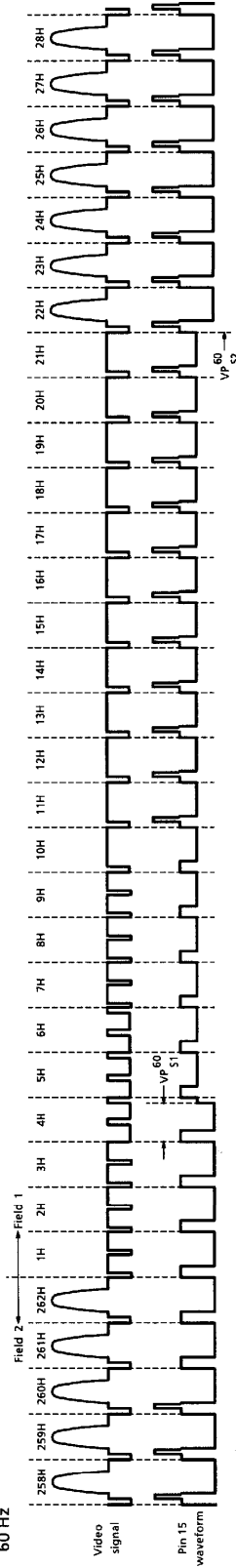

(Note D6) VERTICAL OUTPUT PULSE WIDTH

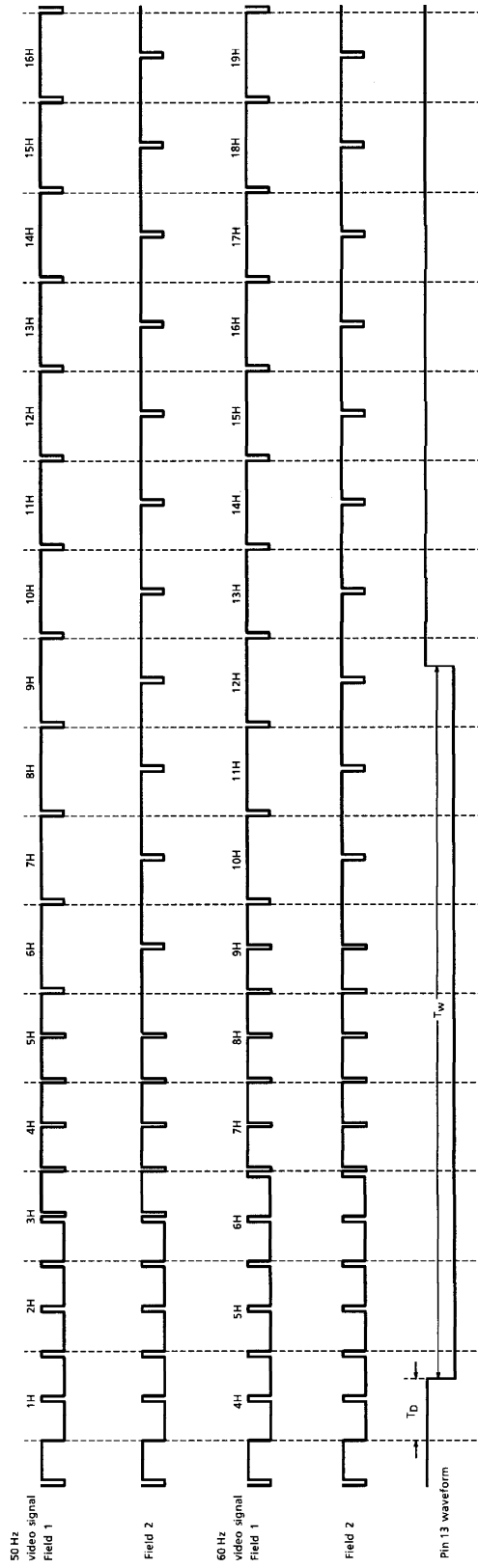

APPLICATION CIRCUIT 1 (NTSC)

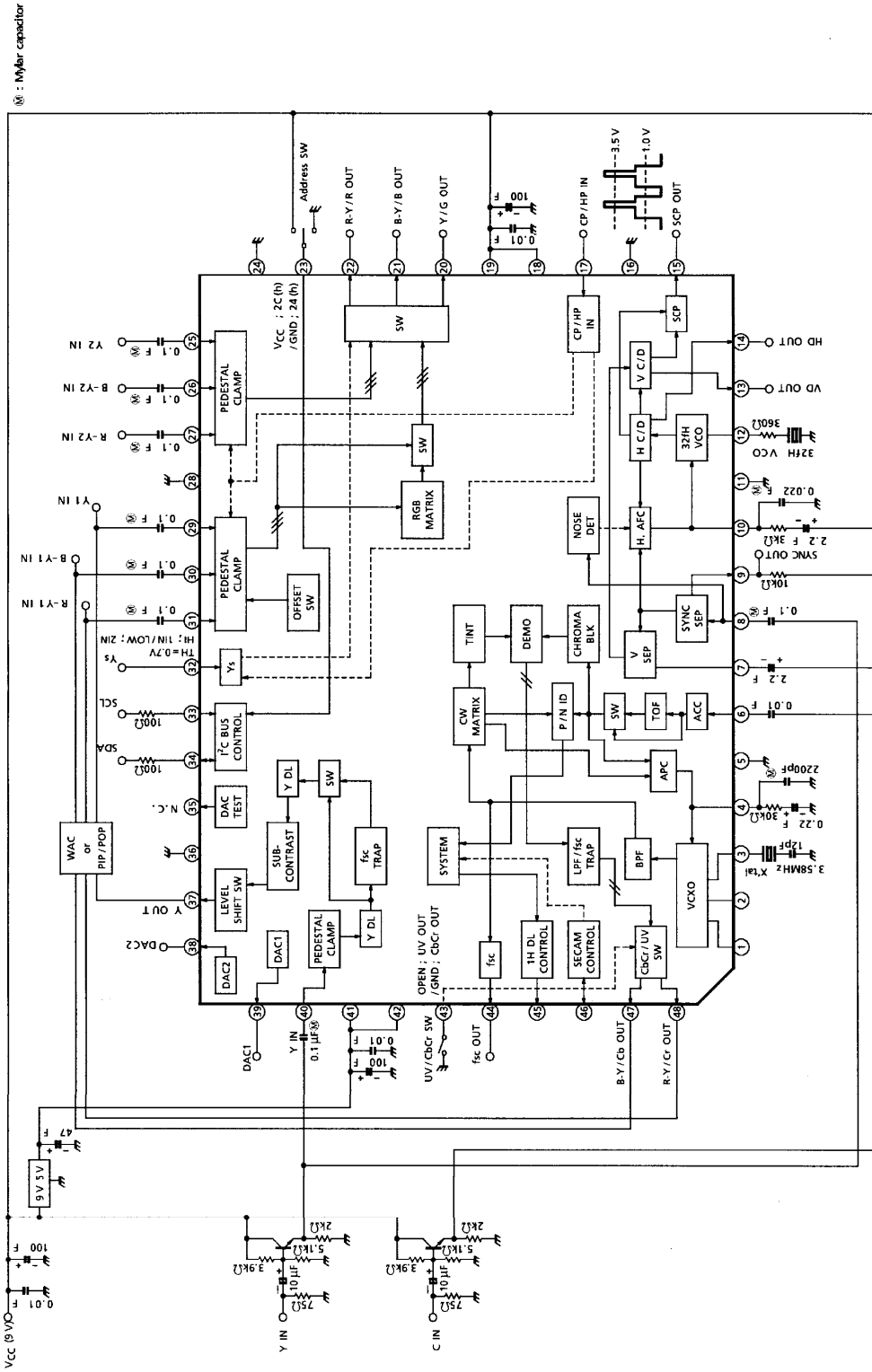

TA1270BF-35

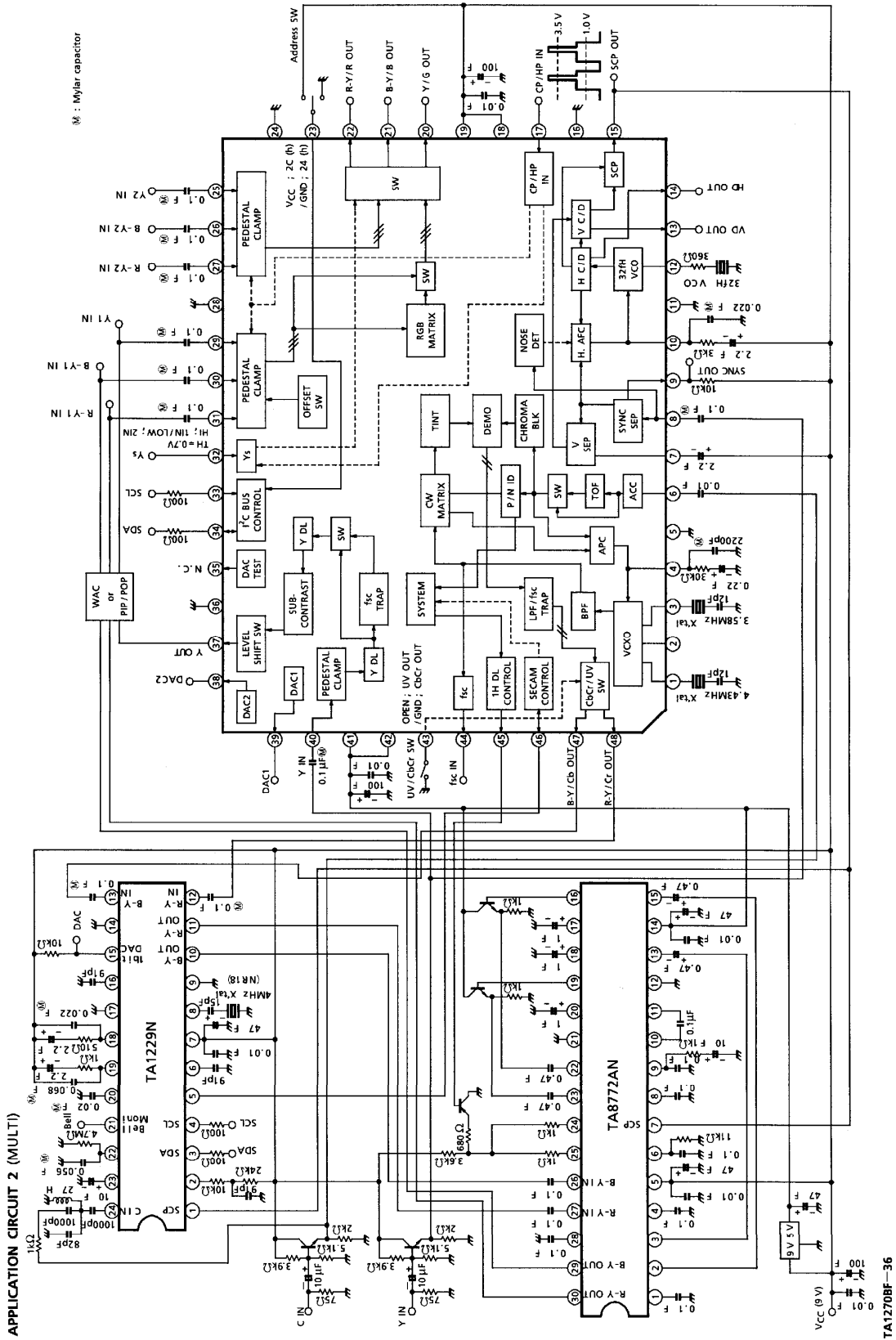

APPLICATION CIRCUIT 3 (South america)

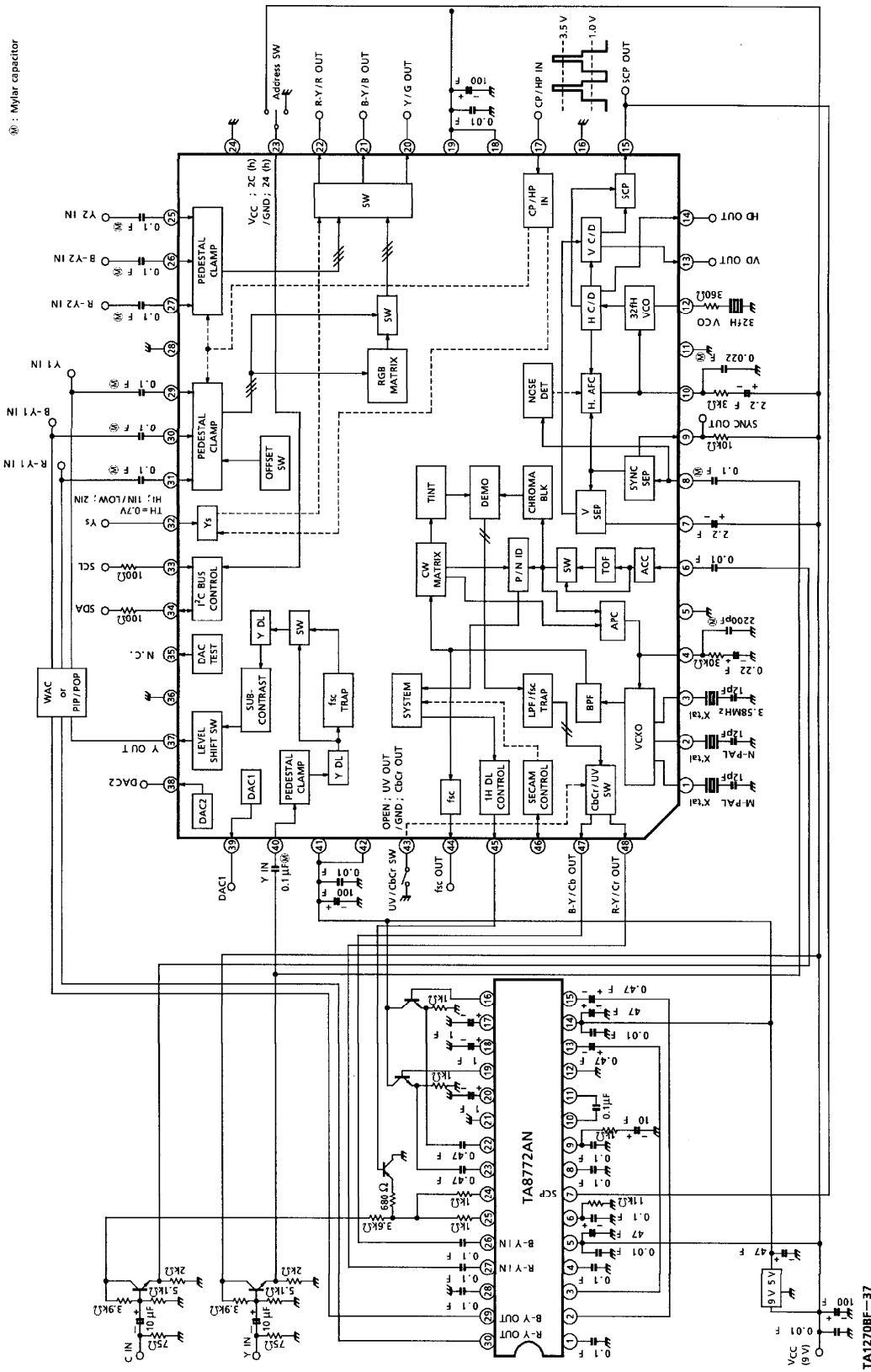

PACKAGE DIMENSIONS
QFP48-P-1014-0.80

Unit : mm

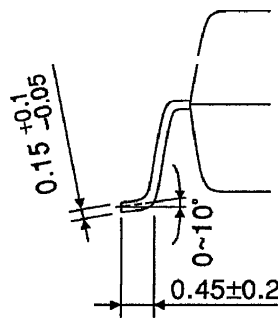
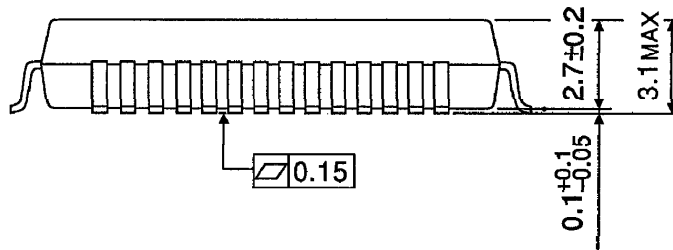
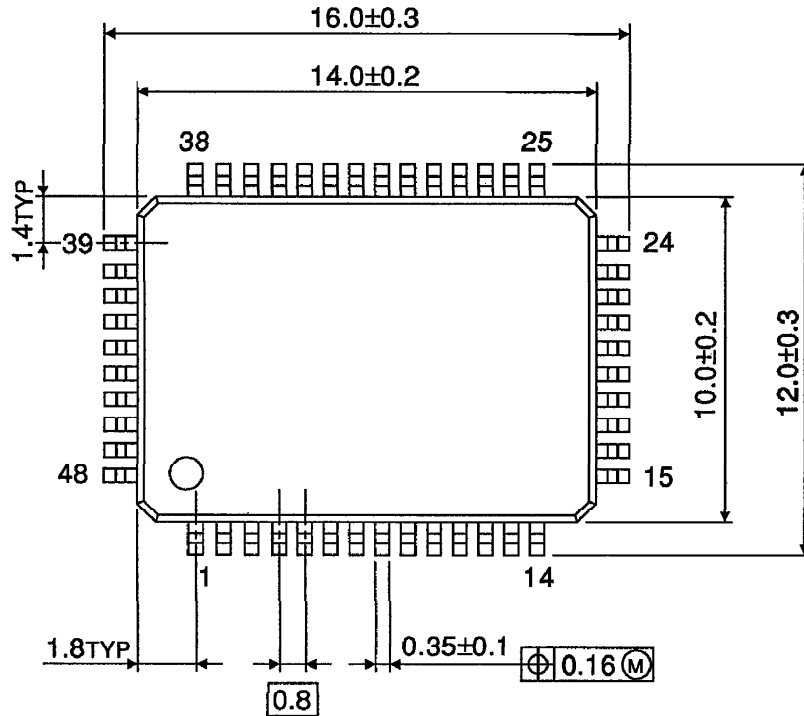

Weight : 0.83 g (Typ.)